

DF4

DT-ENG-DF4-V1 20230921

2 Wire Intercom System

DF4

4.3" TFT Monitor

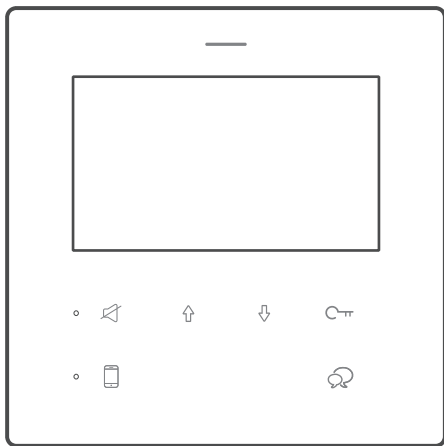

DF4-W DF4-B
DF4-WS DF4-BS

Parts and function

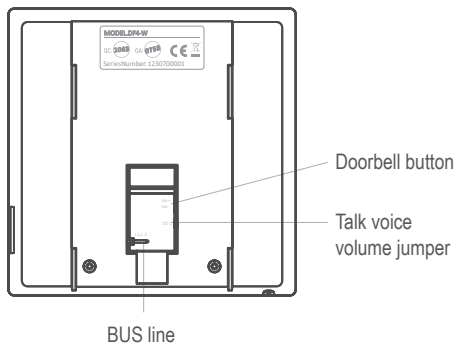
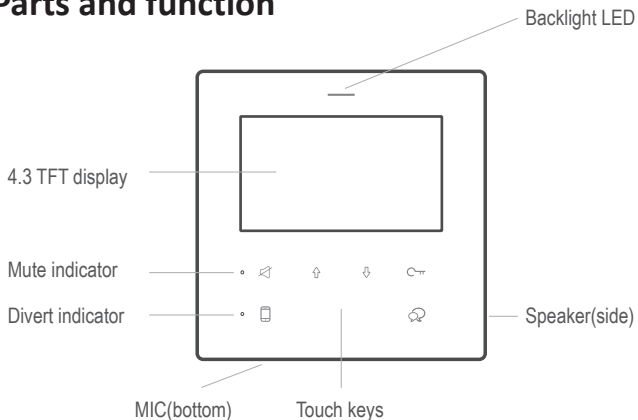

 Talk/Monitor

 Unlock

 Scroll up

 Scroll down

 Mute

 Divert

Talk voice volume jumper: the volume of the speaker voice when talk with door station, plug in means high, remove means low.

Connections

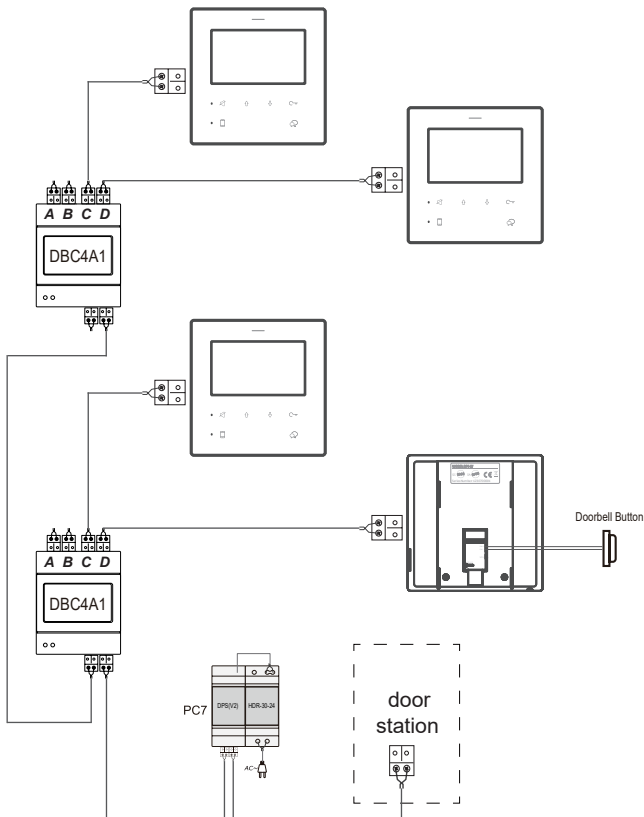

NOTICE: the DF4 monitor does not support DT-IPG, RLC light mode requires update RLC to support.

DF4 monitors does not support in-out connection.

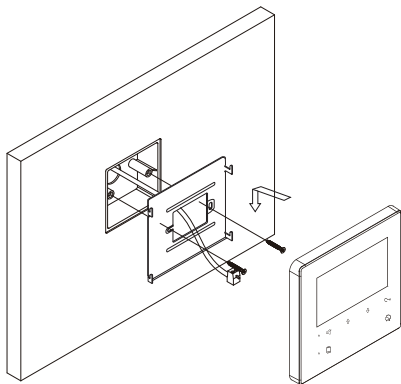

Mounting



Installation Setup



1. Address setup

By monitor menu

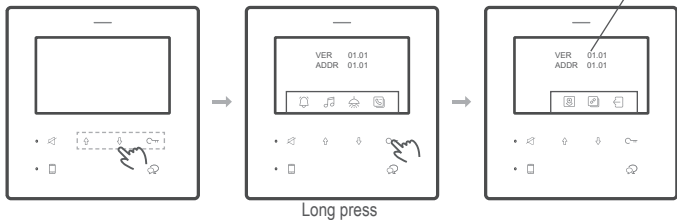
- Tap \downarrow or \uparrow or C , to get into main menu
- In main menu, long press unlock key
- Tap \uparrow (refers ) to set monitor address
- Tap \downarrow (refers ) to set monitor master slave



By call activate

a. When power up and standby (DF4 is screen off), press and hold  for 6s until  flashes.

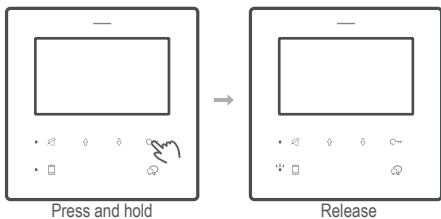

b. Call from door station with designed address, to activate the address..

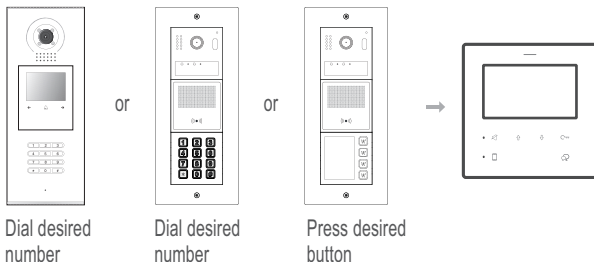

By PG1 programmer

Refer PG1 programmer manual



2. Master/Slave setup

By monitor menu

Refer address setup step 1

3. Auto call back

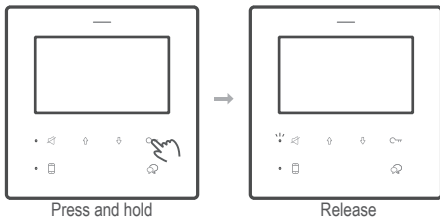

After 1 and 2 setups, DF4 can apply a calling from DF4, simulator a call from door station.

When power up and standby (DF4 is screen off), press and hold  for 3s until  led flashes.





User personalization setup

1. Adjust ringtone volume

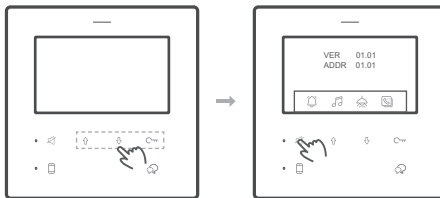
2 levels adjustable. When standby, into main menu, tap  refers  to switch the volume between large and small.



2. Change ringtone melody

3 sets of the ring tune selectable. When standby, into main menu, tap  (refers ) to switch the melody between 3 sets, after switch DF4 will play the melody for door station calling, inner call, and ring button separately.

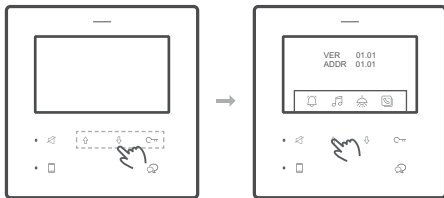

Operation

1. Status setup (Do Not Disturb)

When power up and standby (DF4 is screen off), :

Tap  to enable “Do Not Disturb”, the corresponding LED solid on mean the is in Do Not Disturb and will not ring for any calls.

Tap  to enable/disable “Divert to APP”.

*(*Reserve function, requires additional accessory or specific door station to enable, not working for 2easy standard door station.)*

2. Accept calling



When DF4 rings,

Tap  to accept calling.

Tap  (refers ) to release door lock 1

Tap  (refers ) to release door lock2

Tap  (refers ) to adjust brightness of the image, 2 levels.

Tap  (refers ) to switch to other door station camera(if has)



3. Monitor door station

When power up and standby (DF4 is screen off), or in main menu, tap to start monitoring door station 1.

In monitoring check "Operation, point 2) for operations.

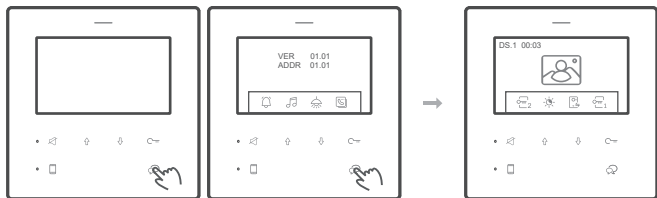

4. Intercom call / Inner call

When power up and standby (DF4 is screen off), into operate menu, tap refer to get into intercom/inner call menu.

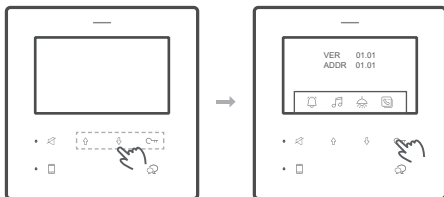

And use ↑ and ↓ to scroll to the address needs to call and tap 🗨 to call, tap 🗨 again to end calling.

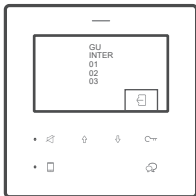

GU: to Guard Unit.

INNER: to monitor with the same address.

5. Operating the light thought DT-RLC/Mini RLC

When power up and standby (DF4 is screen off), into main menu, tap ↓ refer 🌞 to light up RLC's light. When the icon turns in yellow means light up

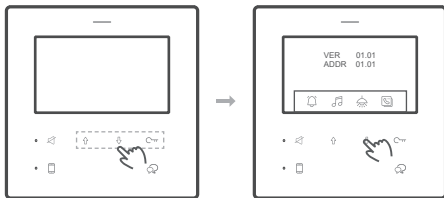

NOTICE: limit support on DT-RLC(with only DT607/608/821,DMR18S)

Restore Factory Setting

To restore to the factory default settings, by following steps.

1. Disconnect the DF4 from bus line, wait for 30s, and connect to bus line.
2. Within 10s power up, press and hold  for 12s, release when and LED flashes.
3. A long beep means all setting rest to factory default

Address will remain while the master/slave will restore

Precautions

1. All components should be protected from violence vibration. And not allow to be impacted, knocked and dropped.
2. Please do the cleanness with soft cotton cloth, please do not use the organic impregnant or chemical clean agent. If necessary, please use a little pure water or dilute soap water to clean the dust.
3. Image distortion may occur if the video monitor is mounted too close to magnetic field e. g. Microwaves, TV, computer etc.
4. Please keep away the monitor from wet, high temperature, dust, caustic and oxidation gas in order to avoid any unpredictable damage.
5. Must use the right adaptor which is supplied by the manufacturer or approved by the manufacturer.
6. Pay attention to the high voltage inside the products, please refer service only to a trained and qualified professional.

Specification

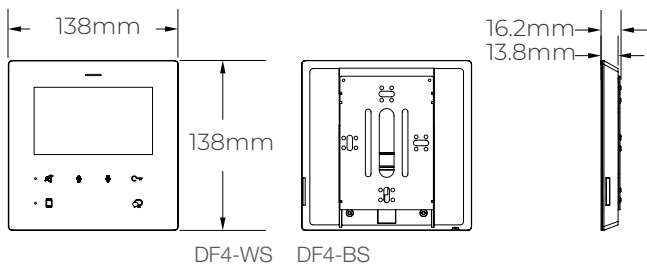
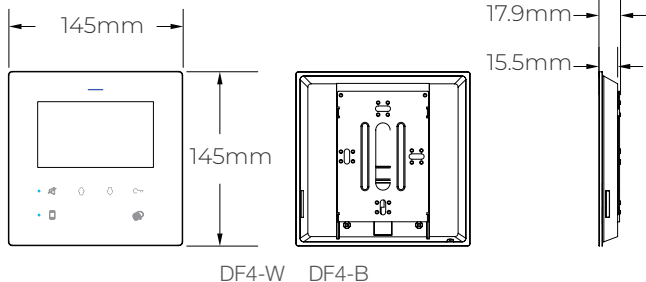

Power Supply: DC20 ~28 V

Power Consumption : standby 9mA,working 150mA

Working Temperature : -15°C ~ +55°C ;

Wiring: 2 wires, non-polarity

Monitor screen: 4.3 Inch digital color LCD

Operation Dimension:

DF4-W, DF4-B:145*145*15.5mm(not include the metal support)

DF4-WS, DF4-BS:138*138*13.8mm(not include the metal support)

DT-ENG-DF4-V1 20230921

The design and specifications can be changed without notice to the user.
Right to interpret and copyright of this manual are preserved.